

# Centre Scientifique et Technique du Bâtiment

84 avenue Jean Jaurès  
CHAMPS-SUR-MARNE  
F-77447 Marne-la-Vallée Cedex 2  
Tél. : (33) 01 64 68 82 82  
Fax : (33) 01 60 05 70 37

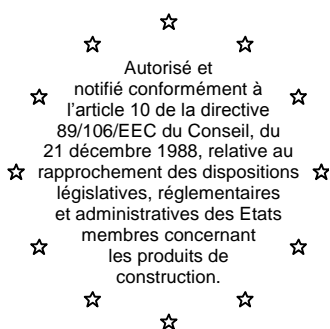

**CSTB**  
le futur en construction

**MEMBRE DE L'EOTA**

## European Technical Approval

## ETA-12/0024

(English language translation, the original version is in French language)

Nom commercial :

**Trade name:**

Titulaire :

**Holder of approval:**

Type générique et utilisation prévue du  
produit de construction :

**Generic type and use of  
construction product:**

Validité du :

au :

**Validity from / to:**

Usine de fabrication :

**Manufacturing plant:**

Le présent Agrément technique européen  
contient :

**This European Technical Approval  
contains:**

**Injection system Chemfix CH+**

**Chemfix Products Ltd  
Mill St East, Dewsbury  
WF12 9BQ West Yorkshire  
United Kingdom**

Cheville à scellement de type "à injection" pour fixation dans le  
béton non fissuré M8 à M24, fers à béton 8 à 25mm.

**Bonded injection type anchor for use in non cracked  
concrete: sizes M8 to M24, rebar 8 to 25mm**

**13/02/2012**

**13/02/2017**

**Chemfix Products Ltd  
Mill St East, Dewsbury  
WF12 9BQ West Yorkshire  
United Kingdom**

21 pages incluant 13 annexes faisant partie intégrante du  
document.

**21 pages including 13 annexes which form an integral part  
of the document.**



Organisation pour l'Agrément Technique Européen  
European Organisation for Technical Approvals

## I LEGAL BASES AND GENERAL CONDITIONS

1. This European Technical Approval is issued by the Centre Scientifique et Technique du Bâtiment in accordance with:
  - Council Directive 89/106/EEC of 21 December 1988 on the approximation of laws, regulations and administrative provisions of Member States relating to construction products<sup>1</sup>, modified by the Council Directive 93/68/EEC of 22 July 1993<sup>2</sup>;
  - Décret n° 92-647 du 8 juillet 1992<sup>3</sup> concernant l'aptitude à l'usage des produits de construction;
  - Common Procedural Rules for Requesting, Preparing and the Granting of European Technical Approvals set out in the Annex of Commission Decision 94/23/EC<sup>4</sup>;
  - Guideline for European Technical Approval of « Metal Anchors for use in Concrete » ETAG 001, edition 1997, Part 1 « Anchors in general » and Part 5 « Bonded anchors».
2. The Centre Scientifique et Technique du Bâtiment is authorised to check whether the provisions of this European Technical Approval are met. Checking may take place in the manufacturing plant (for example concerning the fulfilment of assumptions made in this European Technical Approval with regard to manufacturing). Nevertheless, the responsibility for the conformity of the products with the European Technical Approval and for their suitability for the intended use remains with the holder of the European Technical Approval.
3. This European Technical Approval is not to be transferred to manufacturers or agents of manufacturer other than those indicated on page 1; or manufacturing plants other than those indicated on page 1 of this European Technical Approval.
4. This European Technical Approval may be withdrawn by the Centre Scientifique et Technique du Bâtiment pursuant to Article 5 (1) of the Council Directive 89/106/EEC.
5. Reproduction of this European Technical Approval including transmission by electronic means shall be in full. However, partial reproduction can be made with the written consent of the Centre Scientifique et Technique du Bâtiment. In this case partial reproduction has to be designated as such. Texts and drawings of advertising brochures shall not contradict or misuse the European Technical Approval.
6. The European Technical Approval is issued by the approval body in its official language. This version corresponds to the version circulated within EOTA. Translations into other languages have to be designated as such.

1 Official Journal of the European Communities n° L 40, 11.2.1989, p. 12

2 Official Journal of the European Communities n° L 220, 30.8.1993, p. 1

3 Journal officiel de la République française du 14 juillet 1992

4 Official Journal of the European Communities n° L 17, 20.1.1994, p. 34

## II SPECIFIC CONDITIONS OF THE EUROPEAN TECHNICAL APPROVAL

### 1 Definition of product and intended use

#### 1.1. Definition of product

The injection system Chemfix CH+ is a bonded anchor system (injection type) consisting of a foil pack (or coaxial cartridge or side-by-side cartridge) with injection mortar Chemfix CH+ and a steel element. The steel element can be made of zinc plated carbon, stainless steel, or high corrosion resistant stainless steel (HCR), or rebar.

The steel element is placed into a rotary/percussion drilled hole filled with the injection mortar and is anchored via the bond between the metal part and concrete.

An illustration of the product is provided in the Annexes 1 to 3.

#### 1.2. Intended use

The anchor is intended to be used for anchorages for which requirements for mechanical resistance and long term stability and safety in use in the sense of the Essential Requirements 1 and 4 of Council Directive 89/106/EEC shall be fulfilled and failure of anchorages made with these products would compromise the stability of the works, cause risk to human life and/or lead to considerable economic consequences. Safety in case of fire (Essential Requirement 2) is not covered in this ETA. The anchor is to be used only for anchorages subject to static or quasi-static loading in reinforced or unreinforced normal weight concrete of strength classes C 20/25 at minimum and C50/60 at most according to EN 206-1: 2000-12. It may be anchored in non-cracked concrete only. Overhead use is not permitted.

**The elements made of zinc plated carbon steel** (Threaded rods) may only be used in concrete subject to dry internal conditions.

**The elements made of stainless steel A4** (Threaded rods) may be used in structures subject to dry internal conditions and also in structures subject to external atmospheric exposure (including industrial and marine environment), or exposure in permanently damp internal conditions, if no particular aggressive conditions exist. Such particular aggressive conditions are e.g. permanent, alternating immersion in seawater or the splash zone of seawater, chloride atmosphere of indoor swimming pools or atmosphere with extreme chemical pollution (e.g. in desulphurization plants or road tunnels where de-icing materials are used).

**The elements made of high corrosion resistant stainless steel (HCR)** (Threaded rods HCR) may be used in structures subject to dry internal conditions and also in structures subject to external atmospheric exposure, in permanently damp internal conditions or in other particular aggressive conditions. Such particular conditions are e.g. permanent, alternating immersion in seawater or the splash zone of seawater, chloride atmosphere of indoor swimming pools or atmosphere with chemical pollution (e.g. in desulphurization plants or road tunnels where de-icing materials are used).

#### **Elements made of rebar:**

Post-installed reinforcing bars may be used as anchor designed in accordance with the EOTA Technical Report TR 029 only. Such applications are e.g. concrete overlay or shear dowel connections or the connections of a wall predominantly loaded by shear and compression forces with the foundation, where the reinforcing bars act as dowels to take up shear forces. Connections with post-installed reinforcing bars in concrete structures designed in accordance with EN1992-1-1: 2004 are not covered by this European Technical Approval.

The anchor may be installed in dry or wet concrete for all diameters (use category 1).

Installation	Substrate		
	Dry concrete	Wet concrete	Flooded hole
All diameters	Yes	Yes	Not qualified

The anchor may be used in the following temperature ranges:

- Temperature range I: -40 °C to +40 °C  
 (max long term temperature +24 °C and max short term temperature +40 °C)
- Temperature range II: -40 °C to +80 °C  
 (max long term temperature +50 °C and max short term temperature +80 °C).

The provisions made in this European Technical Approval are based on an assumed intended working life of the anchor of 50 years. The indications given on the working life cannot be interpreted as a guarantee given by the producer, but are to be regarded only as a means for choosing the right products in relation to the expected economically reasonable working life of the works.

## 2 Characteristics of product and methods of verification

### 2.1. Characteristics of product

The steel elements and the mortar foil packs correspond to the drawings and provisions given in Annexes 1 to 2. The characteristic material values, dimensions and tolerances of the anchor not indicated in Annexes 4 to 5 shall correspond to the respective values provided in the technical documentation<sup>5</sup> of this European Technical Approval. The characteristic anchor values for the design of anchorages are provided in Annexes 10 to 13.

The two components of the Chemfix CH+ injection mortar are delivered in an unmixed condition in foil bag cartridges (165 ml, 300 ml or 410 ml), coaxial cartridges (380 ml, 400 ml or 410 ml) or side-by-side cartridges (235 ml, 345 ml, 350 ml or 410 ml) according to Annex 1. Each pack is marked with the identifying; the trade name "Chemfix CH+", batch code (5 figures), either expiry date or manufacture date (plus shelf life).

Commercial standard threaded rods, washers and hexagon nuts can be used if the requirements given in Annex 4, Table 1 or Annex 5, Table 3 and § 4.2.2 are fulfilled.

The marking of embedment depth for the steel element threaded rod and reinforcing bar may be done on jobsite.

### 2.2. Methods of verification

The assessment of suitability of the anchor for the intended use in relation to the requirements for mechanical resistance and stability and safety in use in the sense of the Essential Requirements 1 and 4 has been made in accordance with the « Guideline for European Technical Approval of Metal Anchors for use in Concrete », Part 1 « Anchors in general » and Part 5 « Bonded anchors », on the basis of Option 7.

*In addition to the specific clauses relating to dangerous substances contained in this European Technical Approval, there may be other requirements applicable to the products falling within its scope (e.g. transposed European legislation and national laws, regulations and administrative provisions). In order to meet the provisions of the UE Construction Products Directive, these requirements need also to be complied with, when and where they apply.*

<sup>5</sup> The technical documentation of this European Technical Approval is deposited at the Centre Scientifique et Technique du Bâtiment and, as far as relevant for the tasks of the approved bodies involved in the attestation of conformity procedure, is handed over to the approved bodies.

### **3 Evaluation of Conformity and CE marking**

#### **3.1 Attestation of conformity system**

The system of attestation of conformity 2 (i) (referred to as system 1) according to Council Directive 89/106/EEC Annex III laid down by the European Commission provides:

a) Tasks for the manufacturer:

1. Factory production control,
2. Further testing of samples taken at the factory by the manufacturer in accordance with a prescribed test plan.

b) Tasks for the approved body:

3. Initial type-testing of the product,
4. Initial inspection of factory and of factory production control,
5. Continuous surveillance, assessment and approval of factory production control.

#### **3.2. Responsibilities**

##### **3.2.1 Tasks of the manufacturer, factory production control**

The manufacturer has a factory production control system in the plant and exercises permanent internal control of production. All the elements, requirements and provisions adopted by the manufacturer are documented in a systematic manner in the form of written policies and procedures. This production control system ensures that the product is in conformity with the European Technical Approval.

The manufacturer shall only use raw materials supplied with the relevant inspection documents as laid down in the prescribed test plan<sup>6</sup>. The incoming raw materials shall be subject to controls and tests by the manufacturer before acceptance. Check of incoming materials such as resin and hardener shall include control of the inspection documents presented by suppliers (comparison with nominal values) by verifying appropriate properties.

The frequency of controls and tests conducted during production is laid down in the prescribed test plan taking account of the automated manufacturing process of the anchor.

The results of factory production control are recorded and evaluated. The records include at least the following information:

- designation of the product, basic material and components;
- type of control or testing;
- date of manufacture of the product and date of testing of the product or basic material and components;
- result of control and testing and, if appropriate, comparison with requirements;
- signature of person responsible for factory production control.

The records shall be presented to the inspection body during the continuous surveillance. On request, they shall be presented to the Centre Scientifique et Technique du Bâtiment.

Details of the extent, nature and frequency of testing and controls to be performed within the factory production control shall correspond to the prescribed test plan which is part of the technical documentation of this European Technical Approval.

##### **3.2.2 Tasks of approved bodies**

###### **3.2.2.1 Initial type-testing of the product**

For initial type-testing the results of the tests performed as part of the assessment for the European Technical Approval shall be used unless there are changes in the production line or plant. In such cases the necessary initial type-testing has to be agreed between the Centre Scientifique et Technique du Bâtiment and the approved bodies involved.

<sup>6</sup> The prescribed test plan has been deposited at the Centre Scientifique et Technique du Bâtiment and is only made available to the approved bodies involved in the conformity attestation procedure.

### 3.2.2.2 Initial inspection of factory and of factory production control

The approved body shall ascertain that, in accordance with the prescribed test plan, the factory and the factory production control are suitable to ensure continuous and orderly manufacturing of the anchor according to the specifications mentioned in 2.1 as well as to the Annexes to the European Technical Approval.

### 3.2.2.3 Continuous surveillance

The approved body shall visit the factory at least once a year for regular inspection. It has to be verified that the system of factory production control and the specified automated manufacturing process are maintained taking account of the prescribed test plan.

Continuous surveillance and assessment of factory production control have to be performed according to the prescribed test plan.

The results of product certification and continuous surveillance shall be made available on demand by the certification body or inspection body, respectively, to the Centre Scientifique et Technique du Bâtiment. In cases where the provisions of the European Technical Approval and the prescribed test plan are no longer fulfilled the conformity certificate shall be withdrawn.

## 3.3. CE-Marking

The CE marking shall be affixed on each packaging of anchors. The symbol « CE » shall be accompanied by the following information:

- identification number of the certification body;
- name or identifying mark of the producer and manufacturing plant;
- the last two digits of the year in which the CE-marking was affixed;
- number of the EC certificate of conformity;
- number of the European Technical Approval;
- number of the European Technical Guideline;
- use category (ETAG 001-5 Option 7);
- size.

## 4 Assumptions under which the suitability of the product for the intended use was favourably assessed

### 4.1. Manufacturing

The anchor is manufactured in accordance with the provisions of the European Technical Approval using the automated manufacturing process as identified during inspection of the plant by the Centre Scientifique et Technique du Bâtiment and the approved body and laid down in the technical documentation.

### 4.2. Installation

#### 4.2.1. Design of anchorages

The suitability of the anchor for the intended use is given under the following conditions:

The anchorages are designed in accordance with the EOTA Technical Report TR 029<sup>7</sup> "Design of bonded anchors" under the responsibility of an engineer experienced in anchorages and concrete work. Verifiable calculation notes and drawings are prepared taking account of the loads to be anchored. The position of the anchor is indicated on the design drawings (e.g. position of the anchor relative to reinforcement or to supports, etc.).

<sup>7</sup> The Technical Report TR 029 "Design of Bonded Anchors" is published in English on EOTA website [www.eota.eu](http://www.eota.eu).

Post-installed reinforcing bars may be used as anchor designed in accordance with the EOTA Technical Report TR 029 only. The basic assumptions for the design according to anchor theory shall be observed. This includes the consideration of tension and shear loads and the corresponding failure modes as well as the assumption that the base material (concrete structural element) remains essentially in the serviceability limit state (either non-cracked or cracked) when the connection is loaded to failure. Such applications are e.g. concrete overlay or shear dowel connections or the connections of a wall predominantly loaded by shear and compression forces with the foundation, where the rebars act as dowels to take up shear forces. Connections with reinforcing bars in concrete structures designed in accordance with EN1992-1-1: 2004 (e.g. connection of a wall loaded with tension forces in one layer of the reinforcement with the foundation) are not covered by this European Technical Approval.

#### 4.2.2. Installation of anchors

The suitability for use of the anchor can only be assumed if the anchor is installed as follows:

- anchor installation carried out by appropriately qualified personnel and under the supervision of the person responsible for technical matters on the site;
- use of the anchor only as supplied by the manufacturer without exchanging the components of an anchor;
- commercial standard threaded rods, washers and hexagon nuts may also be used if the following requirements are fulfilled:
  - material, dimensions and mechanical properties of the metal parts according to the specifications given in Annex 5, Table 3,
  - confirmation of material and mechanical properties of the metal parts by inspection certificate 3.1 according to EN 10204:2004, the documents shall be stored,
  - marking of the threaded rod with the envisage embedment depth. This may be done by the manufacturer of the rod or the person on jobsite.
- anchor installation in accordance with the manufacturer's specifications and drawings using the tools indicated in the technical documentation of this European Technical Approval;
- checks before placing the anchor to ensure that the strength class of the concrete in which the anchor is to be placed is in the range;
- check of concrete being well compacted, e.g. without significant air voids;
- keeping the effective anchorage depth;
- keeping of the edge distance and spacing to the specified values without minus tolerances;
- positioning of the drill holes without damaging the reinforcement;
- in case of aborted drill hole, the drill hole shall be filled with mortar;
- cleaning the hole in accordance with Annex 6; before brushing clean the brush and checking whether the brush diameter according to Annex 9 Table 6 is sufficient. The brush shall produce natural resistance as it enters the anchor hole. If this is not the case a new brush or a brush with a larger diameter must be used;
- anchor installation ensuring the specified embedment depth, that is the appropriate depth marking of the anchor not exceeding the concrete surface;
- mortar injection by using the equipment including the special mixing nozzle shown in Annex 1; discarding the first portion of mortar of each new cartridge until an homogeneous colour is achieved; taking from the manufacturer instruction the admissible processing time (open time) of a cartridge as a function of the ambient temperature of the concrete; filling the drill hole uniformly from the drill hole bottom, in order to avoid entrapment of air; removing the special mixing nozzle slowly bit by bit during pressing-out; filling the drill hole with a quantity of the injection mortar corresponding to 2/3 of the drill hole; inserting immediately the threaded rod, slowly and with a slight twisting motion, removing excess of injection mortar around the rod; observing the curing time according to Annex 9 Table 7 until the rod may be loaded; during curing of the injection mortar the temperature of the concrete must not fall below - 10°C and the temperature of the bond material must be +20°C;
- application of the torque moment given in Annex 4 Table 1 using a calibrated torque wrench.

#### 4.2.3. Responsibility of the manufacturer

It is the manufacturer's responsibility to ensure that the information on the specific conditions according to 1 and 2 including Annexes referred to in 4.2.1 and 4.2.2 is given to those who are concerned. This information may be made by reproduction of the respective parts of the European Technical Approval. In addition all installation data shall be shown clearly on the package and/or on an enclosed instruction sheet, preferably using illustration(s).

The minimum data required are:

- drill bit diameter,
- hole depth,
- diameter of anchor rod,
- minimum effective anchorage depth,
- information on the installation procedure, including cleaning of the hole with the cleaning equipments, preferably by means of an illustration,
- material and property class of metal parts acc. to Annex 5, Table 3 & 4,
- anchor component installation temperature,
- ambient temperature of the concrete during installation of the anchor,
- admissible processing time (open time or gel time) of the mortar,
- curing time until the anchor may be loaded as a function of the ambient temperature in the concrete during installation,
- maximum torque moment,
- identification of the manufacturing batch,

All data shall be presented in a clear and explicit form.

## 5 Recommendations concerning packaging, transport and storage.

The mortar cartridges shall be protected against sun radiation and shall be stored according to the manufacturer's installation instructions in dry conditions at temperatures of at least +5°C to not more than +25°C.

Mortar cartridges (foil bag or rigid cartridges) with expired shelf life must no longer be used.

The anchor shall only be packaged and supplied as a complete unit. Foil bags (or cartridges) may be packed separately from metal parts.

**The original French version is  
signed by**

**Le Directeur Technique  
C. BALOCHE**



## Injection Mortar : Chemfix CH+ Resin System

Chubpac® and ChubSeal®  
 Foil Bag Cartridge 165ml - 410ml



Coaxial Cartridge  
 380ml - 410ml

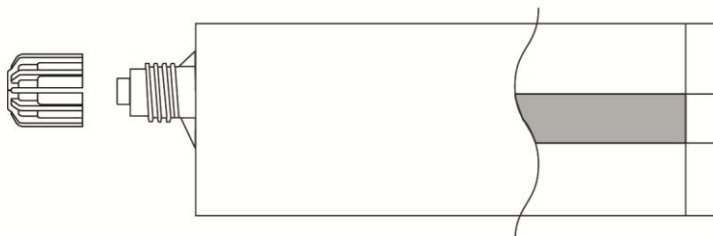

Side by Side Cartridge  
 235ml - 825ml

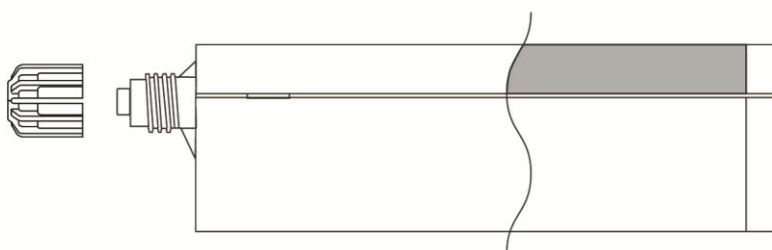

### Marking:

CH+

Batch code, either expiry date or manufacturing date with shelf life

### T-Flow™ Mixer with hanger

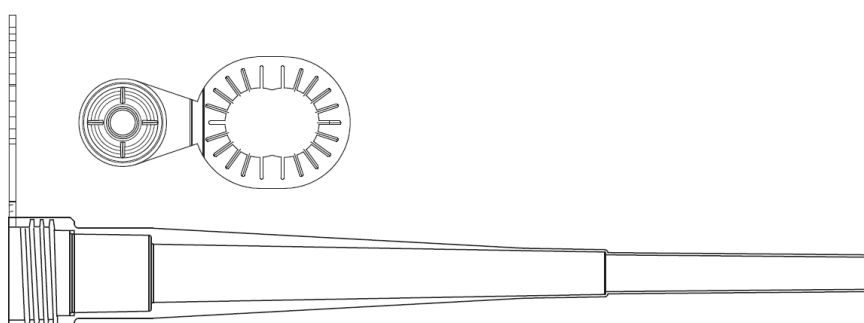

Injection system Chemfix CH+

Product and intended use

Annex 1

of European  
 Technical Approval

ETA - 12/0024

**Anchor rod and rebar:**

**Threaded Steel Stud, Nut and Washer**  
 Sizes M8, M10, M12, M16, M20, M24.

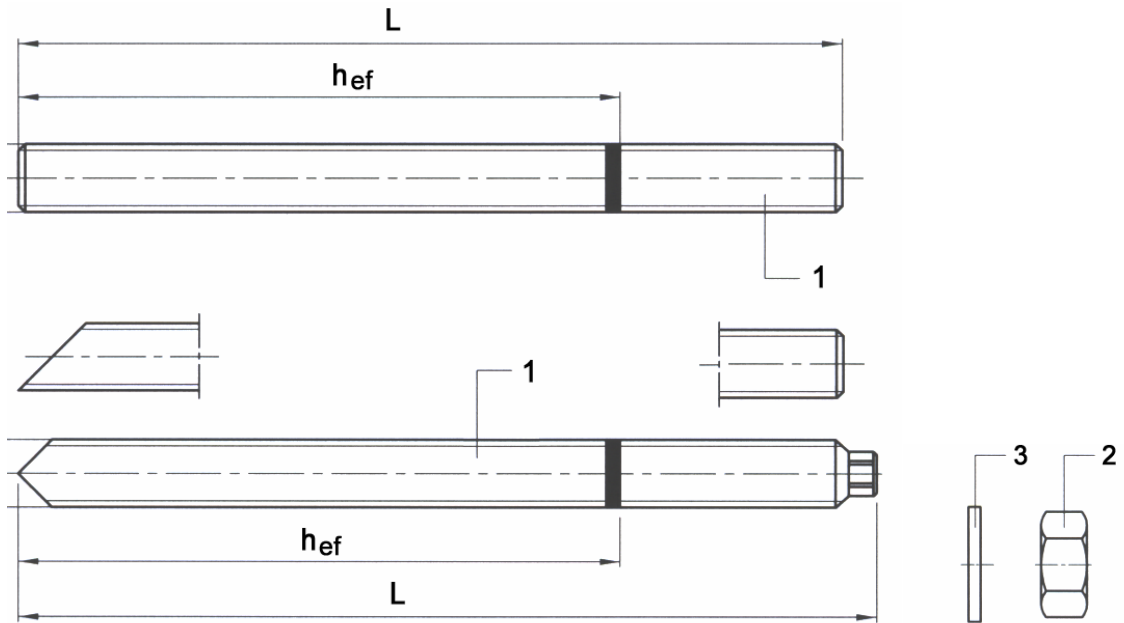

Commercial standard rod with:

- Materials, dimensions and mechanical properties (Table 1a)
- Inspection certificate 3.1 acc. to EN 10204:2004
- Marking of embedment depth

**Rebar**

Diameter  $\varnothing$  8mm,  $\varnothing$  10mm,  $\varnothing$  12mm,  $\varnothing$  14mm,  $\varnothing$  16mm,  $\varnothing$  20mm,  $\varnothing$  25mm



**Injection system Chemfix CH+**

**Product and intended use**

**Annex 2**

of European  
 Technical Approval

**ETA – 12/0024**

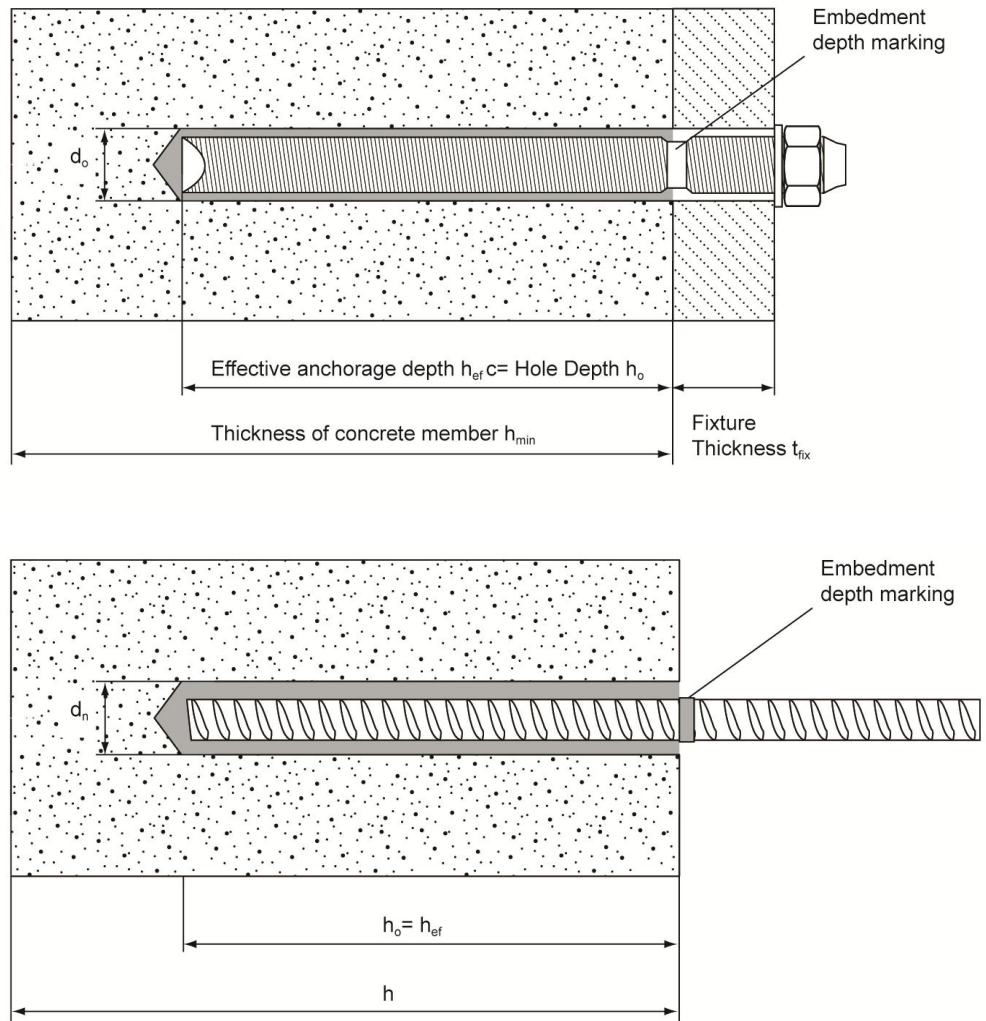

**Intended use**

Use category 1 (according to ETAG 001-5):

Installation in dry or wet concrete.  
 (Not permitted in flooded holes)

Overhead installation is not permitted

**Temperature ranges**

-40°C to +40°C  
 (max. short term temperature +40°C and max. long term temperature +24°C)

-40°C to +80°C  
 (max. short term temperature +80°C and max. long term temperature +50°C)

<b>Injection system Chemfix CH+</b>	<b>Annex 3</b>  of European Technical Approval  <b>ETA – 12/0024</b>
<b>Installed anchor and intended use</b>	

**Table 1: Installation details for anchor rods**

Anchor size		M8	M10	M12	M16	M20	M24
Diameter of anchor rod	d [mm]	8	10	12	16	20	24
Range of anchorage depth $h_{ef}$ and bore hole depth $h_o$	min [mm]	60	60	70	80	90	100
	max [mm]	160	200	240	320	400	480
Nominal anchorage depth	$h_{ef}$ [mm]	80	90	110	125	170	210
Nominal diameter of drill bit	$d_o$ [mm]	10	12	14	18	24	28
Diameter of clearance hole in the fixture	$d_f$ [mm]	9	12	14	18	22	26
Maximum torque moment	$T_{max}$ [Nm]	10	20	30	60	90	140
Minimum thickness of concrete member	$h_{min}$ [mm]	$h_{ef} + 30\text{mm}$ $\geq 100\text{mm}$			$h_{ef} + 2d_o$		
Minimum spacing	$S_{min}$ [mm]	40	50	60	80	100	120
Minimum edge distance	$C_{min}$ [mm]	40	50	60	80	100	120

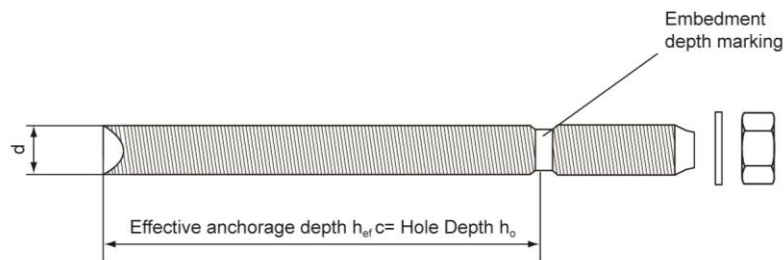

**Table 2 - Installation details for rebars**

Rebar Diameter		Ø8	Ø10	Ø12	Ø14	Ø16	Ø20	Ø25
Diameter of element	D [mm]	8	10	12	14	16	20	25
Range of anchorage depth $h_{ef}$ and bore hole depth $h_o$	min [mm]	60	60	70	75	80	90	100
	max [mm]	160	200	240	280	320	400	500
Nominal diameter of drill bit	$d_o$ [mm]	12	14	16	18	20	25	32
Minimum thickness of concrete member	$h_{min}$ [mm]	$h_{ef} + 30\text{mm}$ $\geq 100\text{mm}$			$h_{ef} + 2d_o$			
Minimum spacing	$S_{min}$ [mm]	40	50	60	70	80	100	125
Minimum edge distance	$C_{min}$ [mm]	40	50	60	70	80	100	125

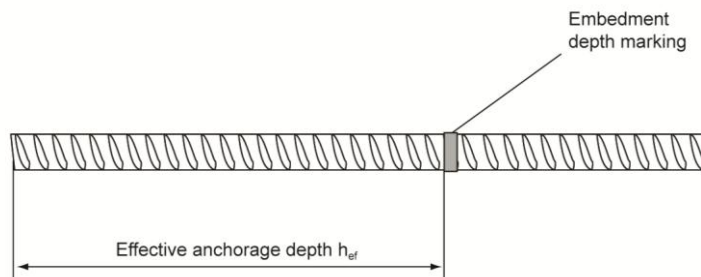

**Injection system Chemfix CH+**

**Installation details  
 Threaded rods and rebars**

**Annex 4**

of European  
 Technical Approval

**ETA – 12/0024**

**Table 3 - Materials**

Designation	Material
<b>Threaded rods made of zinc coated steel</b>	
Threaded rod M8 – M24	Strength class 5.8, 8.8, 10.9 EN ISO 898-1, Steel galvanized $\geq 5\mu\text{m}$ EN ISO 4042, Hot dipped galvanized $\geq 45\mu\text{m}$ EN ISO 10684
Washer ISO 7089	Steel galvanized EN ISO 4042; hot dipped galvanized EN ISO 10684
Nut EN ISO 4032	Strength class 8 EN ISO 898-2 Steel galvanized $\geq 5\mu\text{m}$ EN ISO 4042 Hot dipped galvanized $\geq 45\mu\text{m}$ EN ISO 10684
<b>Threaded rods made of stainless steel</b>	
Threaded rod M8 – M24	For $\leq$ M24: strength class 70 EN ISO 3506-1; Stainless steel 1.4401; 1.4404; 1.4578; 1.4571; 1.4439; 1.4362 EN 10088
Washer ISO 7089	Stainless steel 1.4401; 1.4404; 1.4578; 1.4571; 1.4439; 1.4362 EN 10088
Nut EN ISO 4032	Strength class 70 EN ISO 3506-2 Stainless steel 1.4401; 1.4404; 1.4578; 1.4571; 1.4439; 1.4362 EN 10088
<b>Threaded rods made of high corrosion resistant steel</b>	
Threaded rod M8 – M24	For $\leq$ M20: $R_m = 800\text{ N/mm}^2$ ; $R_{p0,2} = 640\text{ N/mm}^2$ , For $>$ M20: $R_m = 700\text{ N/mm}^2$ ; $R_{p0,2} = 400\text{ N/mm}^2$ , High corrosion resistant steel 1.4529, 1.4565 EN 10088
Washer ISO 7089	High corrosion resistant steel 1.4529, 1.4565 EN 10088
Nut EN ISO 4032	Strength class 70 EN ISO 3506-2 High corrosion resistant steel 1.4529, 1.4565 EN 10088

**Table 4 - Properties of reinforcement bars (rebars)**

Product form		Bars and de-coiled rods	
Class		B	C
Characteristic yield strength $f_{yk}$ or $f_{0,2k}$ (MPa)		400 to 600	
Minimum value of $k = (f_t / f_y)k$		$\geq 1,08$	$\geq 1,15$ < 1,35
Characteristic strain at maximum force, $\epsilon_{uk}$ (%)		$\geq 5,0$	$\geq 7,5$
Bendability		Bend / Rebend test	
Maximum deviation from nominal mass (individual bar) (%)	Nominal bar size (mm) $\leq 8$	$\pm 6,0$ $\pm 4,5$	
	$> 8$		
Bond: Minimum relative rib area, $f_{R,min}$ (determination according to EN 15630)	Nominal bar size (mm) 8 to 12	0,040 0,056	
	$> 12$		

**Height of the rebar rib  $h_{rib}$ :**

The height of the rebar rib  $h_{rib}$  shall fulfil the following requirement:  $0,05 * d \leq h_{rib} \leq 0,07 * d$   
 with:  $d$  = nominal diameter of the rebar

**Injection system Chemfix CH+**

**Materials and properties**

**Annex 5**

of European  
Technical Approval

**ETA – 12/0024**

**Table 5a - Installation parameters: drilling, hole cleaning and installation**

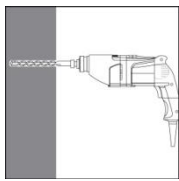
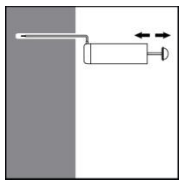
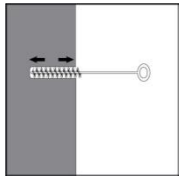
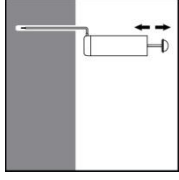
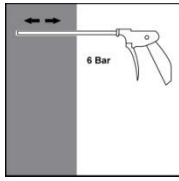
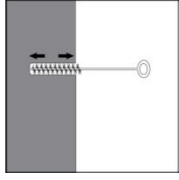
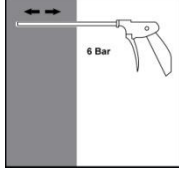
Instructions for use		
Bore hole drilling		
		Drill hole in the substrate to the required embedment depth using the appropriately sized carbide drill bit.
Bore hole cleaning Just before setting an anchor, the bore hole must be free of dust and debris.		
a) Manual air cleaning (MAC) for all bore hole diameters $d_o \leq 24\text{mm}$ and bore hole depth $h_o \leq 10d$		
	<b>X 4</b>	The Chemfix manual pump shall be used for blowing out bore holes up to diameters $d_o \leq 24\text{mm}$ and embedment depths up to $h_{ef} \leq 10d$ .  Blow out at least 4 times from the back of the bore hole, using an extension if needed.
	<b>X 4</b>	Brush 4 times with the specified brush size (see Table 6) by inserting the Chemfix steel brush to the back of the hole (if needed with an extension) in a twisting motion and removing it.
	<b>X 4</b>	Blow out again with manual pump at least 4 times.
b) Compressed air cleaning (CAC) for all bore hole diameters $d_o$ and all bore hole depths		
	<b>X 2</b>	Blow 2 times from the back of the hole (if needed with a nozzle extension) over the whole length with oil-free compressed air (min. 6 bar at 6 m <sup>3</sup> /h).
	<b>X 2</b>	Brush 2 times with the specified brush size (see Table 6) by inserting the Chemfix steel brush to the back of the hole (if needed with an extension) in a twisting motion and removing it.
	<b>X 2</b>	Blow out again with compressed air at least 2 times.

**Injection system Chemfix CH+**

**Instructions for use I**

**Annex 6**

of European  
 Technical Approval

**ETA – 12/0024**

**Table 5b - Installation parameters: drilling, hole cleaning and installation**

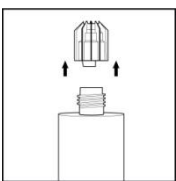
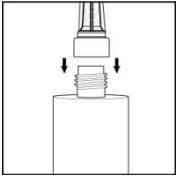
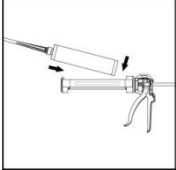
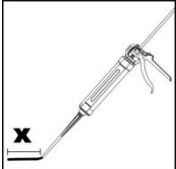
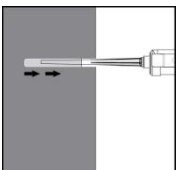
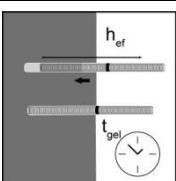
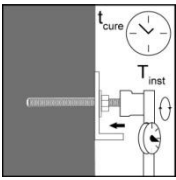
Instructions for use	
	Remove the threaded cap from the cartridge.
	Tightly attach the T-Flow™ mixing nozzle. Do not modify the mixer in any way. Make sure the mixing element is inside the mixer. Use only the supplied mixer.
	Insert the cartridge into the Chemfix dispenser gun.
	Discard the initial trigger pulls of adhesive. Depending on the size of the cartridge, an initial amount of adhesive mix must be discarded.  Discard quantities are - 5cm for between 150ml, 300ml & 400ml Foil Pack - 10cm for all other cartridges
	Inject the adhesive starting at the back of the hole, slowly withdrawing the mixer with each trigger pull. Fill holes approximately 2/3 full, to ensure that the annular gap between the anchor and the concrete is completely filled with adhesive along the embedment depth.
	Before use, verify that the threaded rod is dry and free of contaminants.  Install the threaded rod to the required embedment depth during the open gel time $t_{gel}$ has elapsed. The working time $t_{gel}$ is given in Table 7.
	The anchor can be loaded after the required curing time $t_{cure}$ (see Table 7). The applied torque shall not exceed the values $T_{max}$ given in Table 1.

**Injection system Chemfix CH+**





**Instructions for use II**

**Annex 7**

of European  
 Technical Approval

**ETA – 12/0024**

**Table 6: Bore hole cleaning method with Steel brush**

Threaded rod And rebar	Size	Nominal drill bit diameter d <sub>o</sub> (mm)	Steel Brush	Cleaning methods	
				Manual cleaning (MAC)	Compressed air cleaning (CAC)
					
<b>Studs</b> 	M8	10	12mm	Yes ... h <sub>ef</sub> ≤ 80 mm	Yes
	M10	12	14mm	Yes ... h <sub>ef</sub> ≤ 100mm	
	M12	14	16mm	Yes ... h <sub>ef</sub> ≤ 120mm	
	M16	18	20mm	Yes ... h <sub>ef</sub> ≤ 160mm	
	M20	24	26mm	Yes ... h <sub>ef</sub> ≤ 200mm	
	M24	28	30mm	Yes ... h <sub>ef</sub> ≤ 240mm	
<b>Rebar</b> 	Ø8	12	14mm	Yes ... h <sub>ef</sub> ≤ 80 mm	Yes
	Ø10	14	16mm	Yes ... h <sub>ef</sub> ≤ 100mm	
	Ø12	16	18mm	Yes ... h <sub>ef</sub> ≤ 120mm	
	Ø14	18	20mm	Yes ... h <sub>ef</sub> ≤ 140mm	
	Ø16	20	22mm	Yes ... h <sub>ef</sub> ≤ 160mm	
	Ø20	25	28mm	Yes ... h <sub>ef</sub> ≤ 200mm	
	Ø25	32	34mm	Yes ... h <sub>ef</sub> ≤ 240mm	

**Manual Cleaning (MAC):**

Chemfix hand pump recommended for  
 Blowing out bore holes with diameters  
 d<sub>o</sub> ≤ 24 mm and bore holes depth h<sub>o</sub> ≤ 10d



**Compressed air cleaning (CAC):**

Recommended air nozzle with an  
 Orifice opening of minimum  
 3,5mm in diameter.



**Table 7: Minimum curing time**

Minimum base material temperature C°	Gel time (working time)	Cure time
	In dry/wet concrete	
-10°C ≤ T <sub>base material</sub> < -5°C	125 min	8 hours
-5°C ≤ T <sub>base material</sub> < 0°C	80 min	160 min
0° ≤ T <sub>base material</sub> < 5°C	25 min	90 min
5°C ≤ T <sub>base material</sub> < 10°C	17 min	70 min
10°C ≤ T <sub>base material</sub> < 20°C	12 min	65 min
20°C ≤ T <sub>base material</sub> < 30°C	6 min	60 min
30°C ≤ T <sub>base material</sub> ≤ 40°C	3 min	45 min

The temperature of the bond material must be ≥ 20°C

<b>Injection system Chemfix CH+</b>	<b>Annex 8</b> of European Technical Approval <b>ETA – 12/0024</b>
<b>Installation and cleaning tools</b> <b>Minimum installation times</b>	



**Table 8: Design method A, characteristic tension load values**

Chemfix CH+ with threaded rods			M8	M10	M12	M16	M20	M24
<b>Steel failure</b>								
Characteristic resistance, class 5.8	$N_{Rk,s}$	[kN]	18	29	42	79	123	177
Characteristic resistance, class 8.8	$N_{Rk,s}$	[kN]	29	46	67	126	196	282
Partial safety factor	$\gamma_{Ms,N}^{1)}$	[-]	1,5					
Characteristic resistance, class 10.9	$N_{Rk,s}$	[kN]	36	58	84	157	245	353
Partial safety factor	$\gamma_{Ms,N}^{1)}$	[-]	1.4					
Characteristic resistance, A4-70	$N_{Rk,s}$	[kN]	26	41	59	110	172	247
Partial safety factor	$\gamma_{Ms,N}^{1)}$	[-]	1,87					
Characteristic resistance, HCR	$N_{Rk,s}$	[kN]	29	46	67	126	196	247
Partial safety factor	$\gamma_{Ms,N}^{1)}$	[-]	1,5					
<b>Combined Pull-out and Concrete cone failure <sup>2)</sup></b>								
Diameter of threaded rod	d	[mm]	8	10	12	16	20	24
Characteristic bond resistance in non-cracked concrete C20/25								
Temperature range I <sup>3)</sup> : 40°C/24°C	$\tau_{Rk}$	[N/mm <sup>2</sup> ]	10.0	9.5	9.0	8.0	7.5	7.0
Temperature range II <sup>3)</sup> : 80°C/50°C	$\tau_{Rk}$	[N/mm <sup>2</sup> ]	9.0	8.0	7.5	7.0	6.5	6.0
Increasing factor for $\tau_{Rk,p}$ in non cracked concrete	C30/37		1,12					
	C40/50		1,23					
	C50/60		1,30					
<b>Splitting failure <sup>2)</sup></b>								
Edge distance $c_{cr,sp}$ [mm] for	$h / h_{ef}^{4)} \geq 2,0$		1,0 $h_{ef}$					
	$2,0 > h / h_{ef}^{4)} > 1,3$		4,6 $h_{ef}$ - 1,8 h					
	$h / h_{ef}^{4)} \leq 1,3$		2,25 $h_{ef}$					
Spacing	$s_{cr,sp}$	[mm]	2 $c_{cr,sp}$					
Partial safety factor	$\gamma_{Mp} = \gamma_{Mc} = \gamma_{Msp}^{5)}$	[-]	1,5 <sup>5)</sup>	1,5 <sup>5)</sup>	1,5 <sup>5)</sup>	1,5 <sup>5)</sup>	1,5 <sup>5)</sup>	1,5 <sup>5)</sup>

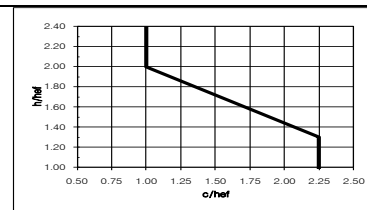

<sup>1)</sup> In absence of national regulations

<sup>2)</sup> Calculation of concrete and splitting, see chapter 4.2.1

<sup>3)</sup> Explanations, see chapter 1.2

<sup>4)</sup> h . concrete member thickness,  $h_{ef}$  ... effective anchorage depth

<sup>5)</sup> The partial safety factor  $\gamma_2 = 1,0$  is included

**Table 9: Displacements under tension <sup>6)</sup>**

Chemfix CH+ with threaded rods			M8	M10	M12	M16	M20	M24
<b>Temperature range I <sup>7)</sup> : 40°C / 24°C</b>								
Displacement	$\delta_{NO}$	[mm/(N/mm <sup>2</sup> )]	0,03	0,03	0,04	0,05	0,06	0,07
Displacement	$\delta_{N\infty}$	[mm/(N/mm <sup>2</sup> )]	0,07	0,09	0,10	0,13	0,17	0,20
<b>Temperature range II <sup>7)</sup> : 80°C / 50°C</b>								
Displacement	$\delta_{NO}$	[mm/(N/mm <sup>2</sup> )]	0,04	0,04	0,05	0,07	0,08	0,10
Displacement	$\delta_{N\infty}$	[mm/(N/mm <sup>2</sup> )]	0,10	0,13	0,15	0,19	0,23	0,28

<sup>6)</sup> Calculation of displacement under service load:  $\tau_{Sd}$  design value of bond stress

Displacement under short term loading =  $\delta_{NO} \cdot \tau_{Sd}/1,4$

Displacement under long term loading =  $\delta_{N\infty} \cdot \tau_{Sd}/1,4$

<sup>7)</sup> Explanation see chapter 1.2

**Injection system Chemfix CH+**

**Threaded Rods :  
 Characteristic tension load values  
 and displacement under tension loads**

**Annex 9**

of European  
 Technical Approval

**ETA – 12/0024**

**Table 10: Design method A, Characteristic shear load values**

Chemfix CH+ with threaded rods			M 8	M 10	M 12	M 16	M 20	M 24
<b>Steel failure without lever arm</b>								
Characteristic resistance, class 5.8	$V_{Rk,s}$ [kN]		9	15	21	39	61	88
Characteristic resistance, class 8.8	$V_{Rk,s}$ [kN]		15	23	34	63	98	141
Characteristic resistance, class 10.9	$V_{Rk,s}$ [kN]		18	29	42	79	123	156
Characteristic resistance, A4-70	$V_{Rk,s}$ [kN]		13	20	30	55.0	86	124
Characteristic resistance, HCR	$V_{Rk,s}$ [kN]		15	23	34	62.8	98	124
<b>Steel failure with lever arm</b>								
Characteristic resistance, class 5.8	$M^0_{Rk,s}$ [Nm]		19	37	66	167	326	561
Characteristic resistance, class 8.8	$M^0_{Rk,s}$ [Nm]		30.0	60	105	266	519	898
Characteristic resistance, class 10.9	$M^0_{Rk,s}$ [Nm]		38	75	131	333	649	893
Characteristic resistance, A4-70	$M^0_{Rk,s}$ [Nm]		26	53	92	233	454	625
Characteristic resistance, HCR	$M^0_{Rk,s}$ [Nm]		30	60	105	266	519	786
<b>Partial safety factor steel failure</b>								
grade 5.8 or 8.8	$\gamma_{Ms,V}^{1)}$ [-]		1,25					
grade 10.9	$\gamma_{Ms,V}^{1)}$ [-]		1,50					
A4-70	$\gamma_{Ms,V}^{1)}$ [-]		1,56					
HCR	$\gamma_{Ms,V}^{1)}$ [-]		1,25					1,75
<b>Concrete pryout failure</b>								
Factor in equation (5.7) of Technical Report TR 029 for the design of bonded anchors	k [-]		2,0					
Partial safety factor	$\gamma_{Mcp}^{1)}$ [-]		1,5 <sup>2)</sup>					
<b>Concrete edge failure<sup>3)</sup></b>								
Partial safety factor	$\gamma_{Mc}^{1)}$ [-]		1,5 <sup>2)</sup>					

<sup>1)</sup> In absence of national regulations.

<sup>2)</sup> The partial safety factor  $\gamma_2 = 1,0$  is included.

<sup>3)</sup> Concrete edge failure see chapter 5.2.3.4 of Technical Report TR 029.

**Table 11: Displacement under shear load <sup>5)</sup>**

Chemfix CH+ with threaded rods			M8	M10	M12	M16	M20	M24
Displacement	$\delta_{V0}$ [mm/kN]		0,06	0,06	0,05	0,04	0,04	0,03
Displacement	$\delta_{V\infty}$ [mm/kN]		0,09	0,08	0,08	0,06	0,06	0,05

<sup>5)</sup> Calculation of displacement under service load:  $V_{Sd}$  design value of shear load

Displacement under short term loading =  $\delta_{V0} \cdot V_{Sd}/1,4$

Displacement under long term loading =  $\delta_{V\infty} \cdot V_{Sd}/1,4$

**Injection system Chemfix CH+**

**Threaded Rods :  
 Characteristic shear load values  
 and displacements under shear load**

**Annex 10**

of European  
 Technical Approval

**ETA – 12/0024**

**Table 12: Design method A, Characteristic tension load values**

Chemfix CH+ with rebar			Ø8	Ø10	Ø12	Ø14	Ø16	Ø20	Ø25	
<b>Steel failure rebar</b>										
Characteristic resistance for rebar BSt 500 S acc. to DIN 488 <sup>1)</sup>	$N_{Rk,s}$	[kN]	28	43	62	85	111	173	270	
Partial safety factor for rebar BSt 500 S acc. to DIN 488 <sup>2)</sup>	$\gamma_{Ms,N}$ <sup>3)</sup>	[-]	1,4							
<b>Combined Pull-out and Concrete cone failure <sup>4)</sup></b>										
Diameter of rebar	d	[mm]	8	10	12	14	16	20	25	
Characteristic bond resistance in non-cracked concrete C20/25										
Temperature range I <sup>5)</sup> :	40°C/24°C	$\tau_{Rk}$	[N/mm <sup>2</sup> ]	7,0	7,5	7,0	7,0	6,5	6,5	6,0
Temperature range II <sup>5)</sup> :	80°C/50°C	$\tau_{Rk}$	[N/mm <sup>2</sup> ]	6.5	6.5	6,0	6,0	6,0	5,5	5,5
Increasing factor for $\tau_{Rk,p}$ in non cracked concrete	$\psi_c$	C30/37	1,12							
		C40/50	1,23							
		C50/60	1,30							
<b>Splitting failure <sup>4)</sup></b>										
Edge distance $c_{cr,sp}$ [mm] for	$h / h_{ef} \geq 2,0$		1,0 $h_{ef}$							
	$2,0 > h / h_{ef} > 1,3$		4,6 $h_{ef}$ - 1,8 h							
	$h / h_{ef} \leq 1,3$		2,26 $h_{ef}$							
Spacing	$s_{cr,sp}$	[mm]	2 $c_{cr,sp}$							
Partial safety factor	$\gamma_{Mp} = \gamma_{Mc} = \gamma_{Msp}$ <sup>3)</sup>	[-]	1,8 <sup>7)</sup>	1,8 <sup>7)</sup>	1,8 <sup>7)</sup>	1,8 <sup>7)</sup>	1,8 <sup>7)</sup>	1,8 <sup>7)</sup>	1,8 <sup>7)</sup>	

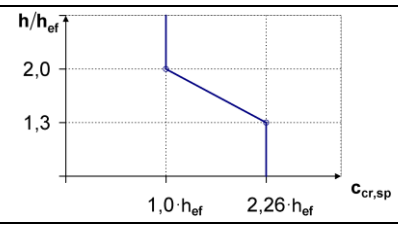

- <sup>1)</sup> The characteristic tension resistance  $N_{Rk,s}$  for rebars that do not fulfil the requirements acc. DIN 488 shall be calculated acc. Technical Report TR029, Equation (5.1).
- <sup>2)</sup> The partial safety factor  $\gamma_{Ms,N}$  for rebars that do not fulfil the requirements acc. DIN 488 shall be calculated acc. Technical Report TR029, Equation (3.3a).
- <sup>3)</sup> In absence of national regulations
- <sup>4)</sup> Calculation of concrete failure and splitting see chapter 4.2.1
- <sup>5)</sup> Explanation see chapter 1.2
- <sup>6)</sup> h ... concrete member thickness,  $h_{ef}$  effective anchorage depth
- <sup>7)</sup> The partial safety factor  $\gamma_2 = 1,2$  is included.

**Table 13: Displacements under tension load <sup>8)</sup>**

Chemfix CH+ with rebar			Ø8	Ø10	Ø12	Ø14	Ø16	Ø20	Ø25
<b>Temperature range I <sup>9)</sup>: 40°C / 24°C</b>									
Displacement	$\delta_{N0}$	[mm/(N/mm <sup>2</sup> )]	0,03	0,03	0,04	0,04	0,05	0,06	0,07
Displacement	$\delta_{N\infty}$	[mm/(N/mm <sup>2</sup> )]	0,07	0,09	0,10	0,12	0,13	0,17	0,20
<b>Temperature range II <sup>9)</sup>: 80°C / 50°C</b>									
Displacement	$\delta_{N0}$	[mm/(N/mm <sup>2</sup> )]	0,04	0,04	0,05	0,06	0,07	0,08	0,10
Displacement	$\delta_{N\infty}$	[mm/(N/mm <sup>2</sup> )]	0,10	0,13	0,15	0,17	0,19	0,23	0,29

- <sup>8)</sup> Calculation of displacement under service load:  $\tau_{Sd}$  design value of bond stress  
 Displacement under short term loading =  $\delta_{N0} \cdot \tau_{Sd}/1,4$   
 Displacement under long term loading =  $\delta_{N\infty} \cdot \tau_{Sd}/1,4$
- <sup>9)</sup> Explanation see chapter 1.2

**Regarding design of post-installed rebar as anchor see chapter 4.2.1**

<b>Injection system Chemfix CH+</b>  <b>Rebars:</b> <b>Characteristic tension load values</b> <b>and displacement under tension loads</b>	<b>Annex 11</b> of European Technical Approval  <b>ETA – 12/0024</b>
---	--

**Table 14: Design method A, Characteristic shear load values**

Chemfix CH+ with rebar			Ø8	Ø10	Ø12	Ø14	Ø16	Ø20	Ø25
<b>Steel failure without lever arm</b>									
Characteristic shear resistance for rebar BSt 500 S acc. to DIN 488 <sup>1)</sup>	$V_{Rk,s}$	[kN]	14	22	31	42	55	86	135
Partial safety factor for rebar BSt 500 S acc. to DIN 488 <sup>2)</sup>	$\gamma_{Ms,V}$	<sup>3)</sup> [-]	1,5						
<b>Steel failure with lever arm</b>									
Characteristic shear resistance for rebar BSt 500 S acc. to DIN 488 <sup>4)</sup>	$M^0_{Rk,s}$	[Nm]	33	65	112	178	265	518	1012
Partial safety factor for rebar BSt 500 S acc. to DIN 488 <sup>2)</sup>	$\gamma_{Ms,V}$	<sup>3)</sup> [-]	1,5						
<b>Concrete pryout failure</b>									
Factor in equation (5.7) of Technical Report TR 029 for the design of bonded anchors	k	[-]	2,0						
Partial safety factor	$\gamma_{Mcp}$	<sup>3)</sup> [-]	1,5 <sup>5)</sup>						
<b>Concrete edge failure <sup>6)</sup></b>									
Partial safety factor	$\gamma_{Mc}$	<sup>3)</sup> [-]	1,5 <sup>5)</sup>						

- 1) The characteristic shear resistance  $V_{Rk,s}$  for rebars that do not fulfil the requirements acc. DIN 488 shall be calculated acc. Technical Report TR029, Equation (5.6).
- 2) The partial safety factor  $\gamma_{Ms,V}$  for rebars that do not fulfil the requirements acc. DIN 488 shall be calculated acc. Technical Report TR029, Equation (3.3b).or (3.3c)..
- 3) In absence of national regulations
- 4) The characteristic bending resistance  $M^0_{Rk,s}$  for rebars that do not fulfil the requirements acc. DIN 488 shall be calculated acc. Technical Report TR029, Equation (5.6b).
- 5) The partial safety factor  $\gamma_2 = 1,0$  is included.
- 6) Concrete edge failure see chapter 5.2.3.4 of Technical Report TR 029.

**Table 15: Displacements under shear load <sup>7)</sup>**

Chemfix CH+ with rebar			Ø8	Ø10	Ø12	Ø14	Ø16	Ø20	Ø25
Displacement	$\delta_{V0}$	[mm/kN]	0,06	0,05	0,05	0,04	0,04	0,04	0,03
Displacement	$\delta_{V\infty}$	[mm/kN]	0,09	0,08	0,07	0,06	0,06	0,05	0,05

- <sup>7)</sup> Calculation of displacement under service load:  $V_{Sd}$  design value of shear load  
 Displacement under short term loading =  $\delta_{sN0} \cdot V_{Sd}/1,4$   
 Displacement under long term loading =  $\delta_{V\infty} \cdot V_{Sd}/1,4$

**Regarding design of post-installed rebar as anchor see chapter 4.2.1**

<b>Injection system Chemfix CH+</b>	<b>Annex 12</b> of European Technical Approval <b>ETA – 12/0024</b>
<b>Rebars:</b> <b>Characteristic values and displacement for shear load</b>	

**Works Underwater**

**Re rebar**

**Hi load**





# CH+

MADE IN THE UK

## Chemical Anchoring Injection System



styrene free

**HEALTH AND SAFETY**

**HANDLING AND STORAGE:**  
 Store in dry conditions away from direct sunlight between +5°C and +25°C.



**ENVIRONMENTAL CARE:** Please do not dispose of unused material. If disposing please use any waste product in its closed state.

## 410ml

BATCH CODE / DATE OF EXPIRY

**HEALTH AND SAFETY**

S2: Keep out of the reach of children.  
 S24: Avoid contact with skin.  
 S37: Wear suitable gloves.  
 Contains diisocyanol peroxide.  
 May produce an allergic reaction.



ISO 14001:2004



Manufactured by:  
 Chemfix Products Limited  
 Mill Street East  
 Dewsbury  
 West Yorkshire  
 WF12 9BQ, UK

Tel +44 (0) 1924 453886  
 Fax +44 (0) 1924 433658  
 www.chemfix.co.uk

**DESCRIPTION**

VINYLESTER anchor mortar is a two-part chemical anchoring system based on a high reactivity vinyl ester resin. ETA approved. Suitable for corrosion resistance and damp applications.

**GEL & CURE TIMES**

Temperature (°C)	Minimum setting time (min)	Minimum setting time (min)	Minimum setting time (min)	Minimum setting time (min)
20	15	30	45	60
15	20	35	50	65
10	25	40	55	70
5	30	45	60	75
0	35	50	65	80
-5	40	55	70	85
-10	45	60	75	90

**EXTRUDE UNMIXED MATERIAL TO WASTE**



! Thorough hole cleaning prior to installation is vital to the performance of the fixing.

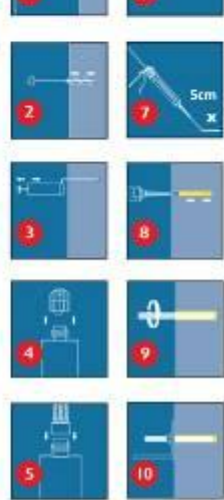

04349

<p><b>Injection system Chemfix CH+</b></p>	<p><b>Annex 13</b> of European Technical Approval</p>
<p><b>Published Installation Instructions</b></p>	<p><b>ETA – 12/0024</b></p>